

Detail A

Detail B

Perforation pattern: Globe G1F (Ø6mm hole cc 15mm)
 Perforation percentage: 9,8 %
 Edge type: Designpanel B (Tapered edge)
 Module: 900 x 2700 x 12,5mm
 Visible measure (primary): 900 x 2700mm
 External measure (secondary): 900 x 2700mm
 A measure: 60mm
 Perforation picture: 3 x (780 x 780mm (53 x 53 holes))

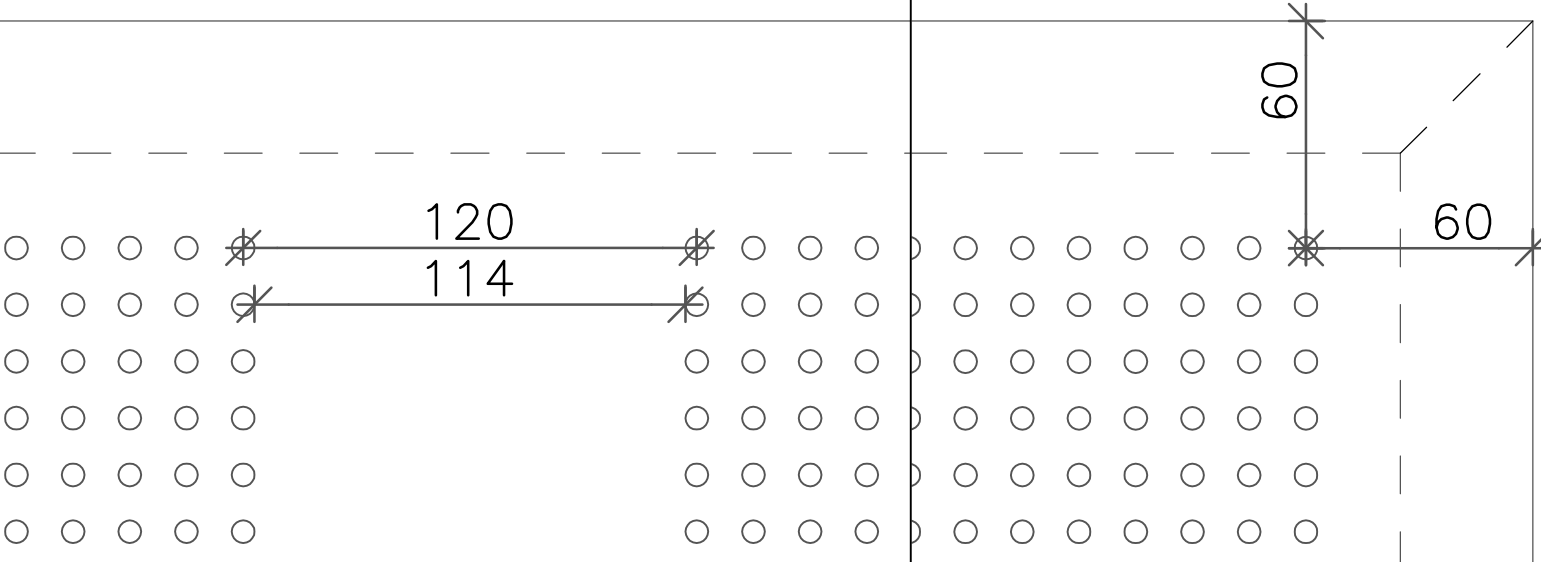

| | |
|--|------------------|
| Project: Designpanel B, Module 900x2700, Globe G1F | MDM no.: 254180 |
| Subject: | Scale: |
|  | Date: 2018-07-09 |
| | Rev.: |
| <small>Knauf Danoline A/S Kløvermarksvej 6, DK-9500 Hobro T: +45 9657 3000 F: +45 9657 3001 www.knaufdanoline.com - info@knaufdanoline.com</small> | Sign.: NPJ |
| | Project no.: |
| | File: |

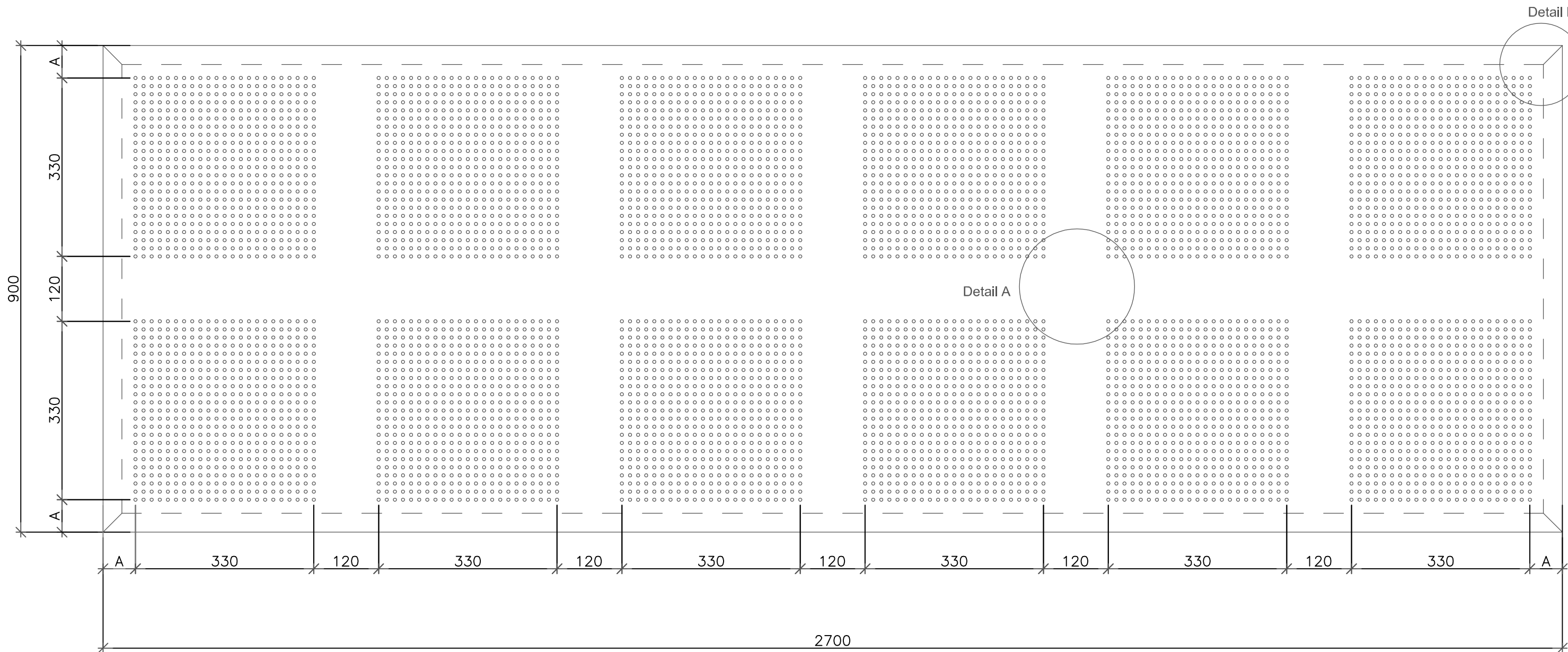

Detail A

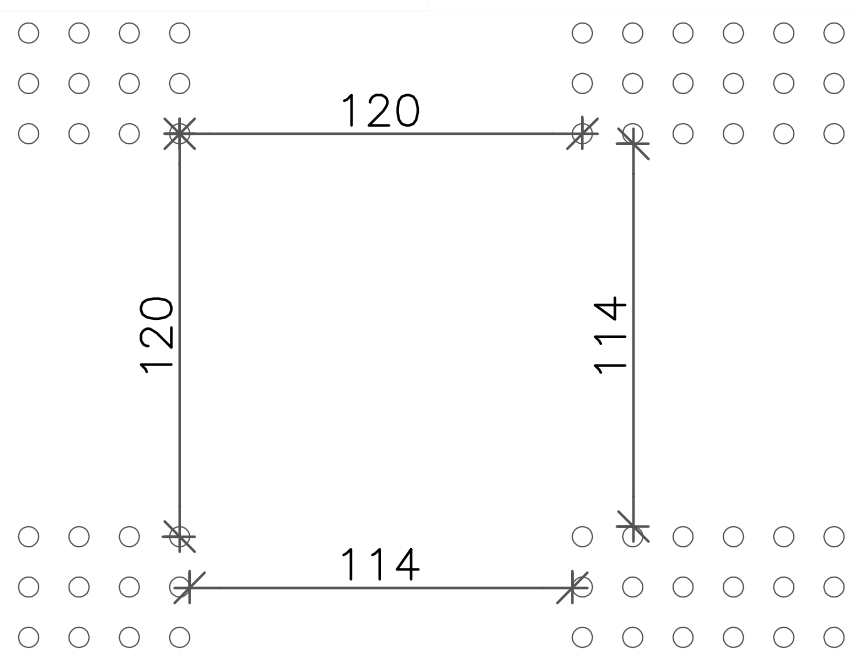

Detail B

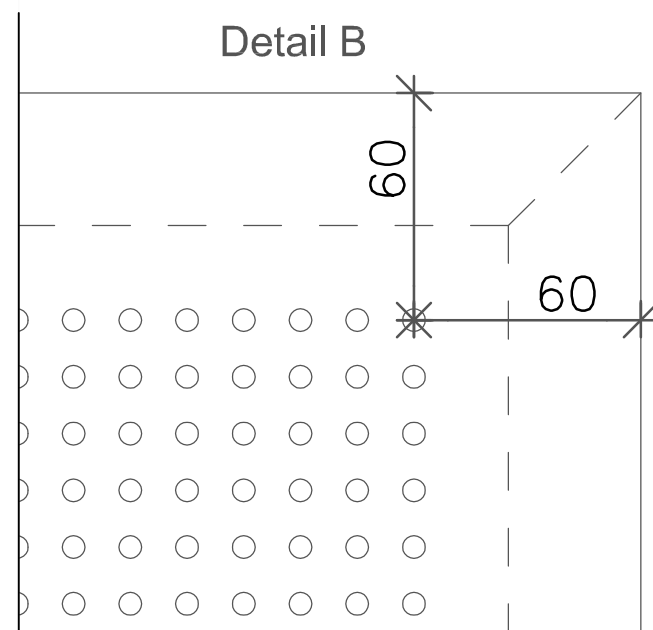

Perforation pattern: Globe G2F (Ø6mm hole cc 15mm)
 Perforation percentage: 7,4 %
 Edge type: Designpanel B (Tapered edge)
 Module: 900 x 2700 x 12,5mm
 Visible measure (primary): 900 x 2700mm
 External measure (secondary): 900 x 2700mm
 A measure: 60mm
 Perforation picture: 12 x (330 x 330mm (23 x 23 holes))

| | |
|--|------------------|
| Project: Designpanel B, Module 900x2700, Globe G2F | MDM no.: 254181 |
| Subject: | Scale: |
|  | Date: 2018-07-09 |
| | Rev.: |
| <small>Knauf Danoline A/S Kløvermarksvej 6, DK-9500 Hobro T: +45 9657 3000 F: +45 9657 3001 www.knaufdanoline.com - info@knaufdanoline.com</small> | Sign.: NPJ |
| | Project no.: |
| | File: |

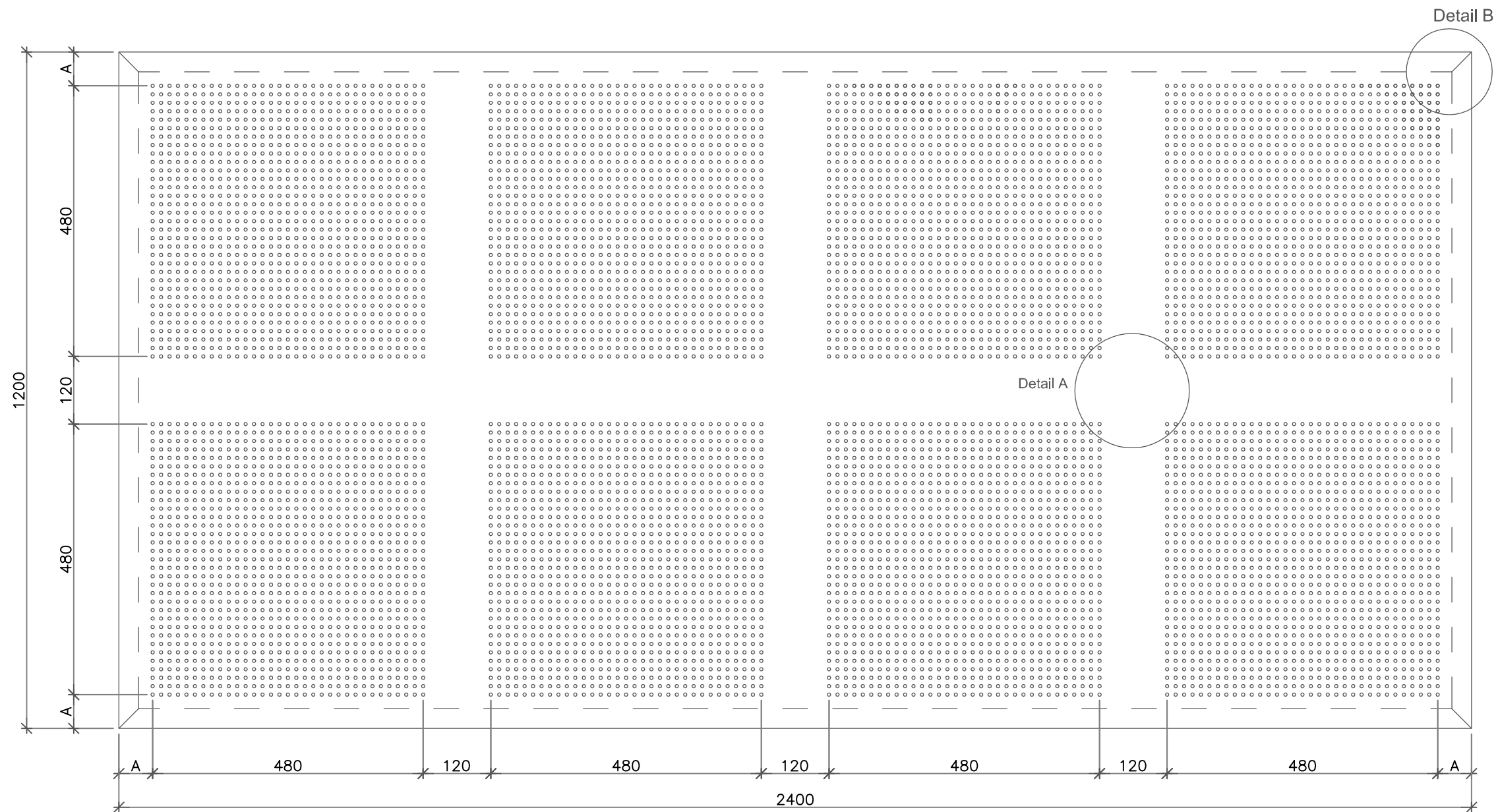

Detail A

Detail B

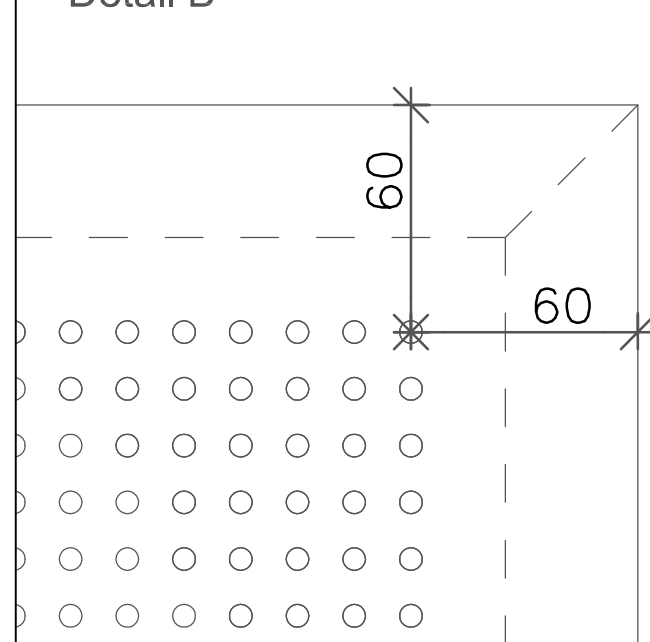
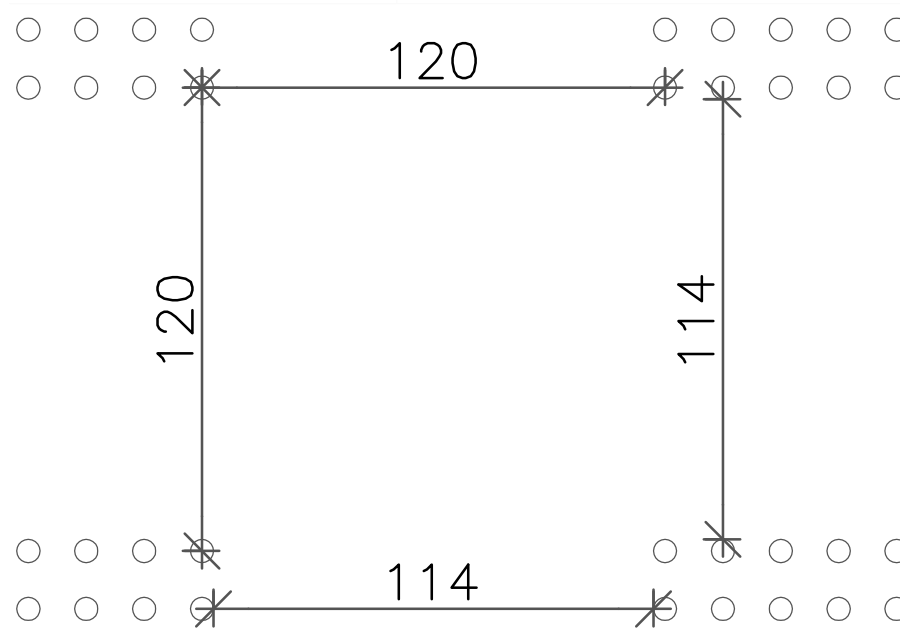

Perforation pattern: Globe G2F (Ø6mm hole cc 15mm)
 Perforation procentage: 8,6 %
 Edge type: Designpanel B (Tapered edge)
 Module: 1200 x 2400 x 12,5mm
 Visible measure (primary): 1200 x 2400mm
 External measure (secondary): 1200 x 2400mm
 A measure: 60mm
 Perforation picture: (2x4) x (480 x 480mm (33 x 33 holes))

| | |
|---|------------------|
| Project: Designpanel B, Module 1200x2400, Globe G2F | MDM no.: 254207 |
| Subject: | Scale: |
| KNAUF DANOLINE | Date: 2018-07-10 |
| | Rev.: |
| | Sign.: NPJ |
| | Project no.: |
| Knauf Danoline A/S Kløvermarksvej 6, DK-9500 Hobro T: +45 9657 3000 F: +45 9657 3001 www.knaufdanoline.com - info@knaufdanoline.com | File: |

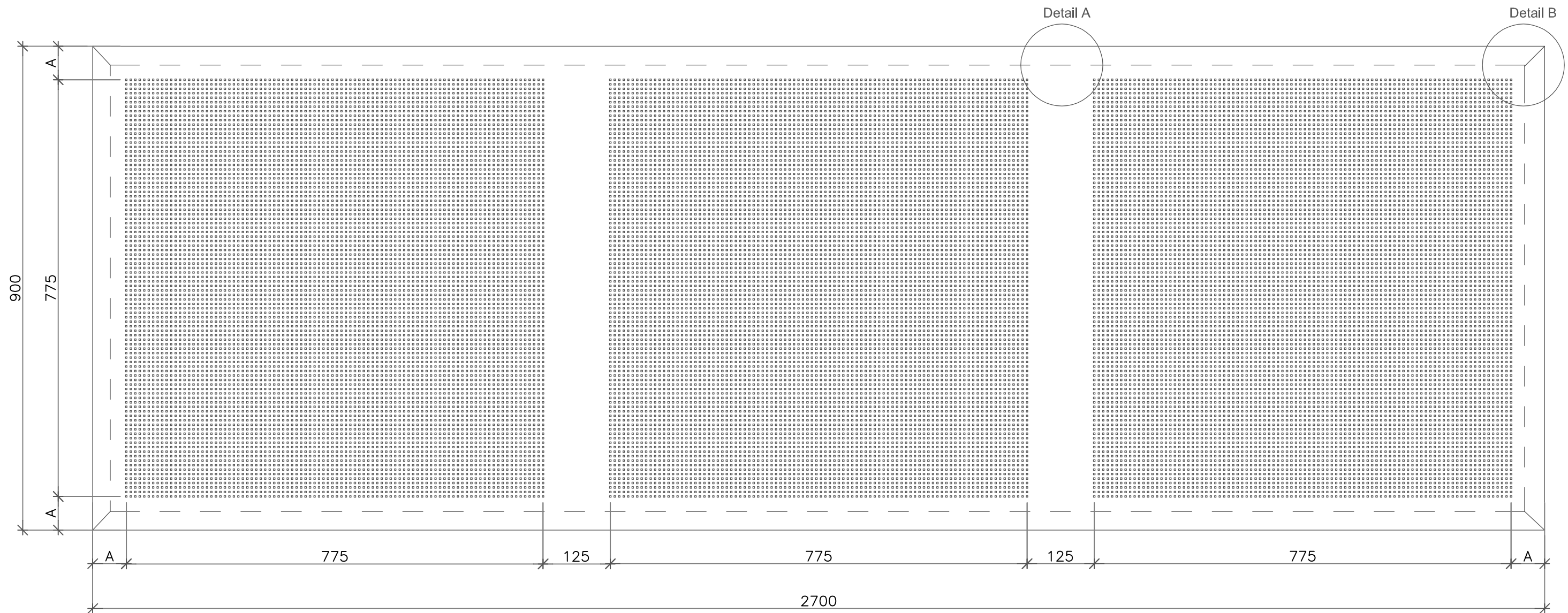

Detail A

Detail B

Detail A

Detail B

- Perforation pattern: Micro M1F (3x3mm holes cc 8,3mm)
- Perforation procentage: 9,8 %
- Edge type: Designpanel B (Tapered edge)
- Module: 900 x 2700 x 12,5mm
- Visible measure (primary): 900 x 2700mm
- External measure (secondary): 900 x 2700mm
- A measure: 62,5mm
- Perforation picture: 3 x (775 x 775mm (94 x 94 holes))

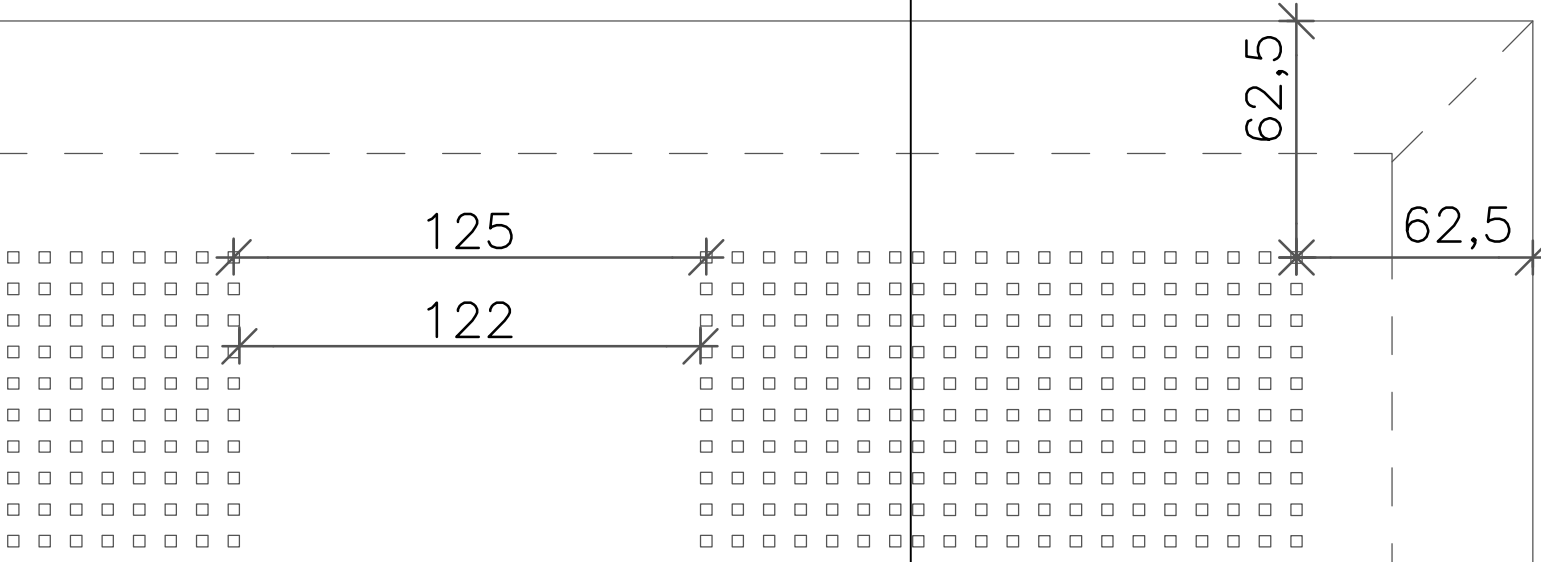

| | |
|---|------------------|
| Project: Designpanel B, Module 900x2700, Micro M1F | MDM no.: 130073 |
| Subject: | Scale: |
| KNAUF DANOLINE | Date: 2018-07-09 |
| | Rev.: |
| Knauf Danoline A/S Kløvermarksvej 6, DK-9500 Hobro T: +45 9657 3000 F: +45 9657 3001 www.knaufdanoline.com - info@knaufdanoline.com | Sign.: NPJ |
| | Project no.: |
| | File: |

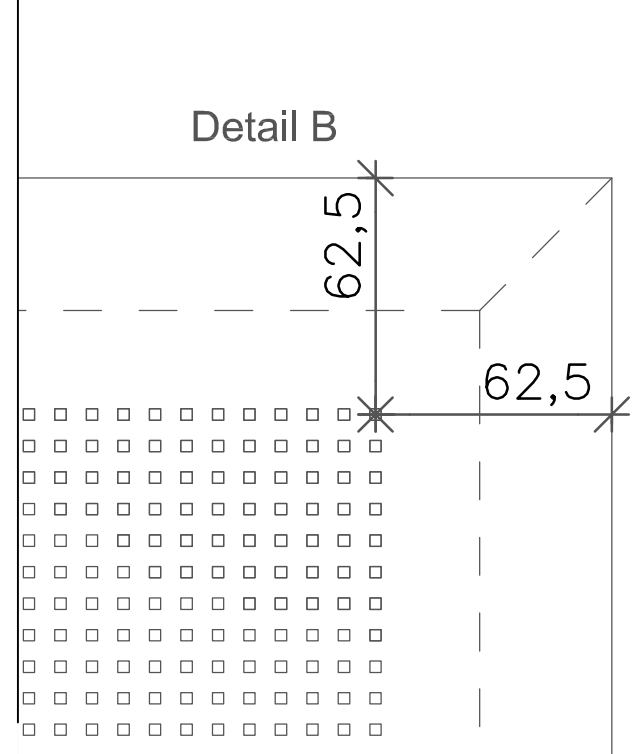
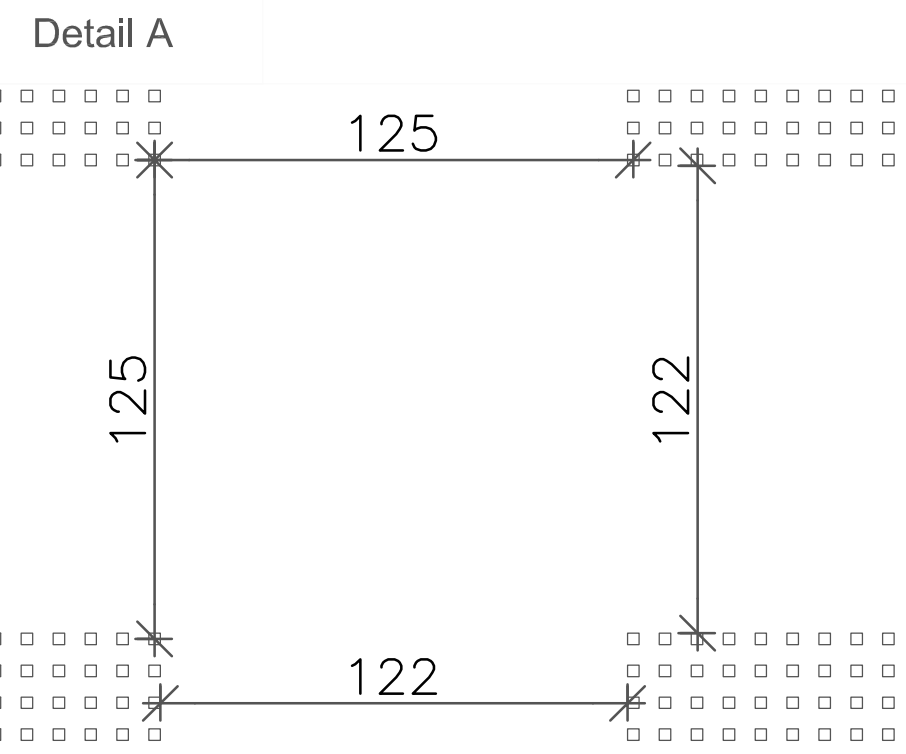
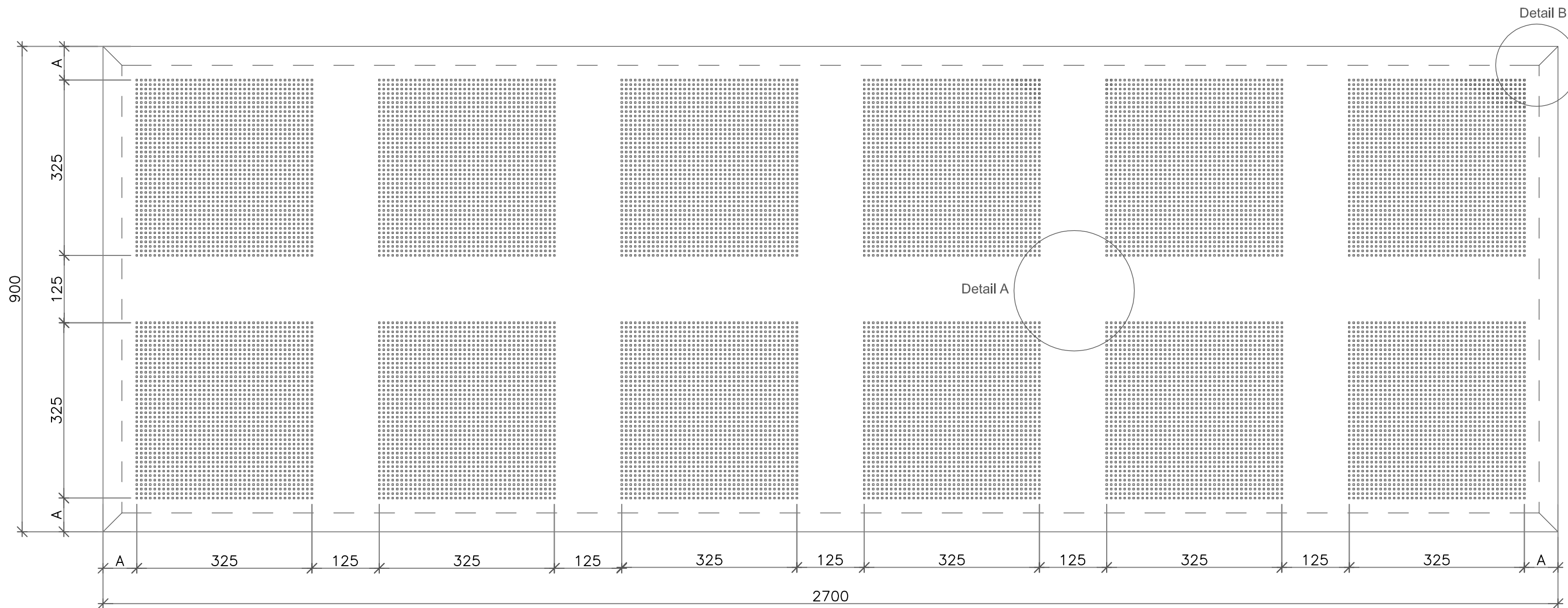

Perforation pattern: Micro M2F (3x3mm holes cc 8,3mm)
 Perforation procentage: 7,1 %
 Edge type: Designpanel B (Tapered edge)
 Module: 900 x 2700 x 12,5mm
 Visible measure (primary): 900 x 2700mm
 External measure (secondary): 900 x 2700mm
 A measure: 62,5mm
 Perforation picture: (2x6) x (325 x 325mm (40x40 holes))

| | | | |
|---|---|--------------|------------|
| Project: | Designpanel B, Module 900x2700, Micro M2F | MDM no.: | 254182 |
| Subject: | | Scale: | |
|  | | Date: | 2018-07-09 |
| | | Rev.: | |
| | | Sign.: | NPJ |
| | | Project no.: | |
| | | File: | |

Knauf Danoline A/S Kløvermarksvej 6, DK-9500 Hobro
 T: +45 9657 3000 F: +45 9657 3001
 www.knaufdanoline.com - info@knaufdanoline.com

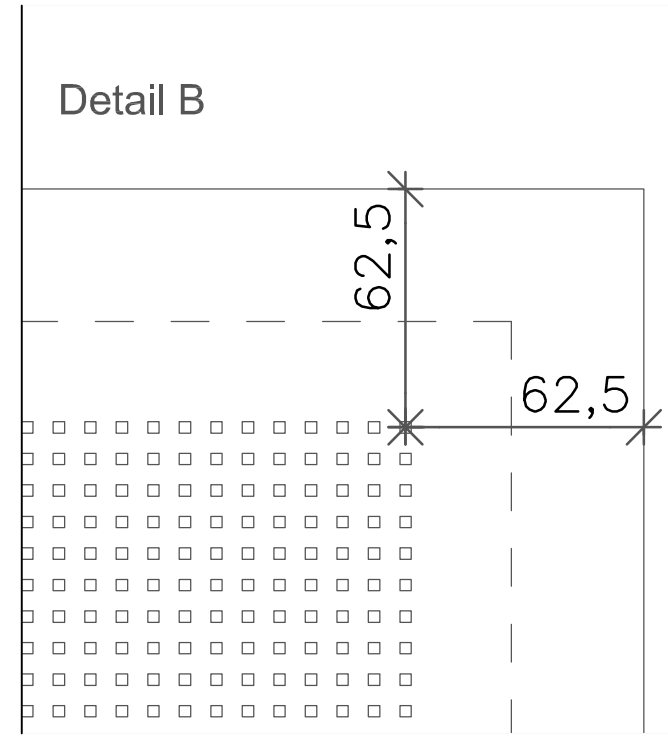
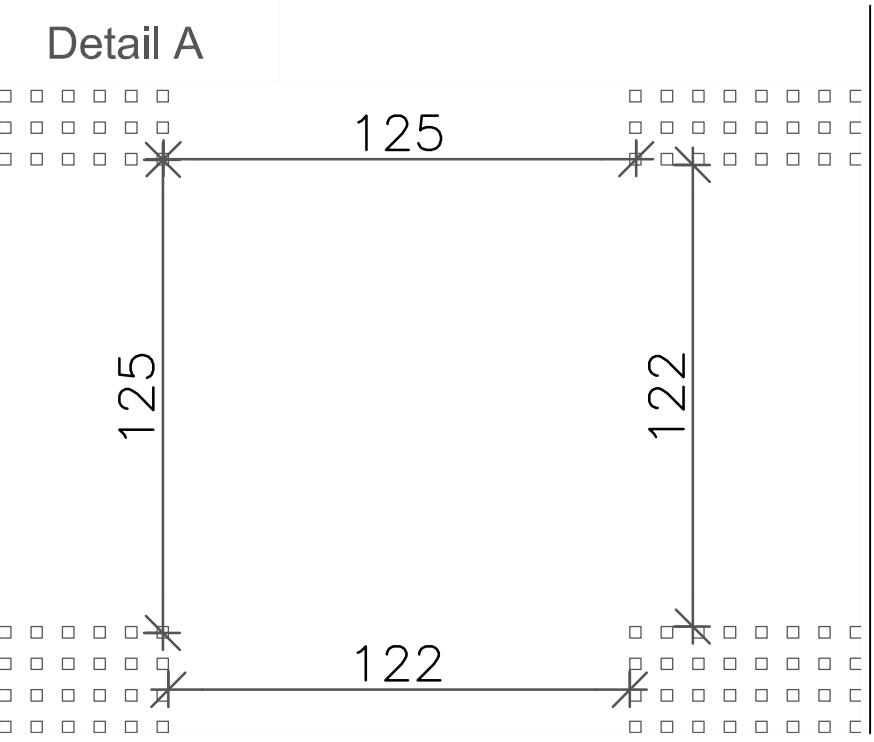
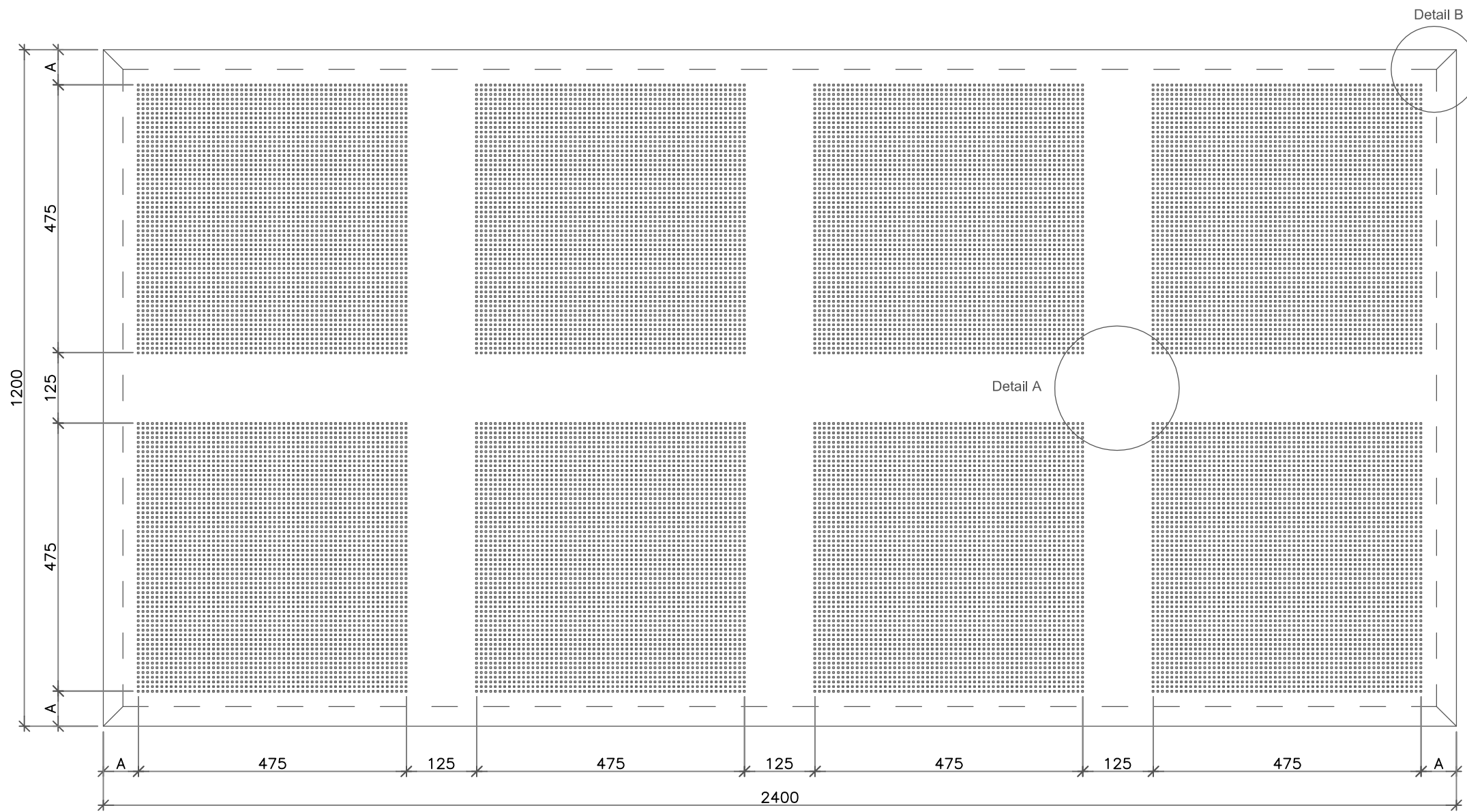

Perforation pattern: Micro M2F (3x3mm holes cc 8,3mm)
 Perforation percentage: 8,4 %
 Edge type: Designpanel B (Tapered edge)
 Module: 1200 x 2400 x 12,5mm
 Visible measure (primary): 1200 x 2400mm
 External measure (secondary): 1200 x 2400mm
 A measure: 62,5mm
 Perforation picture: (2x4) x (475 x 475mm (58x58 holes))

| | | | |
|---|--|--------------|------------|
| Project: | Designpanel B, Module 1200x2400, Micro M2F | MDM no.: | 130075 |
| Subject: | | Scale: | |
|  | | Date: | 2018-07-10 |
| | | Rev.: | |
| | | Sign.: | NPJ |
| | | Project no.: | |
| | | File: | |

Knauf Danoline A/S Kløvermarksvej 6, DK-9500 Hobro
 T: +45 9657 3000 F: +45 9657 3001
 www.knaufdanoline.com - info@knaufdanoline.com

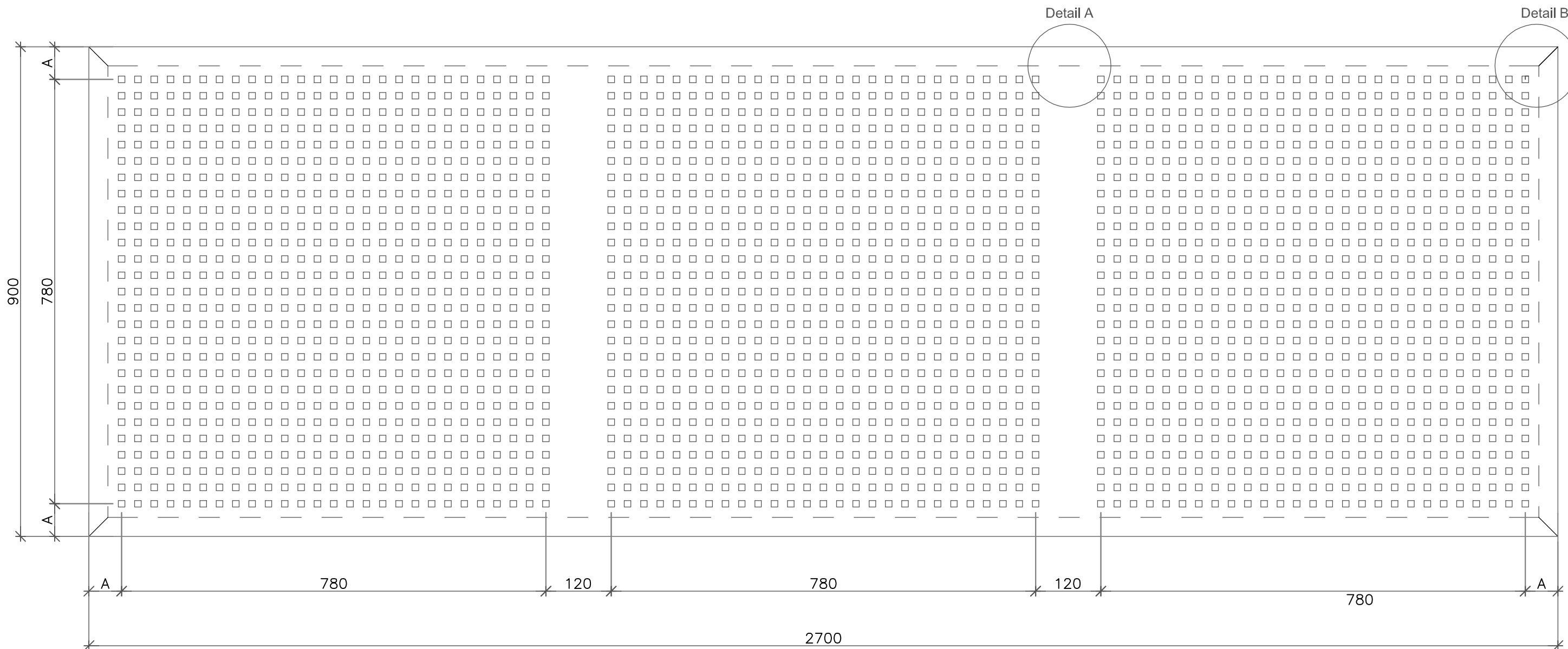

Detail A

Detail B

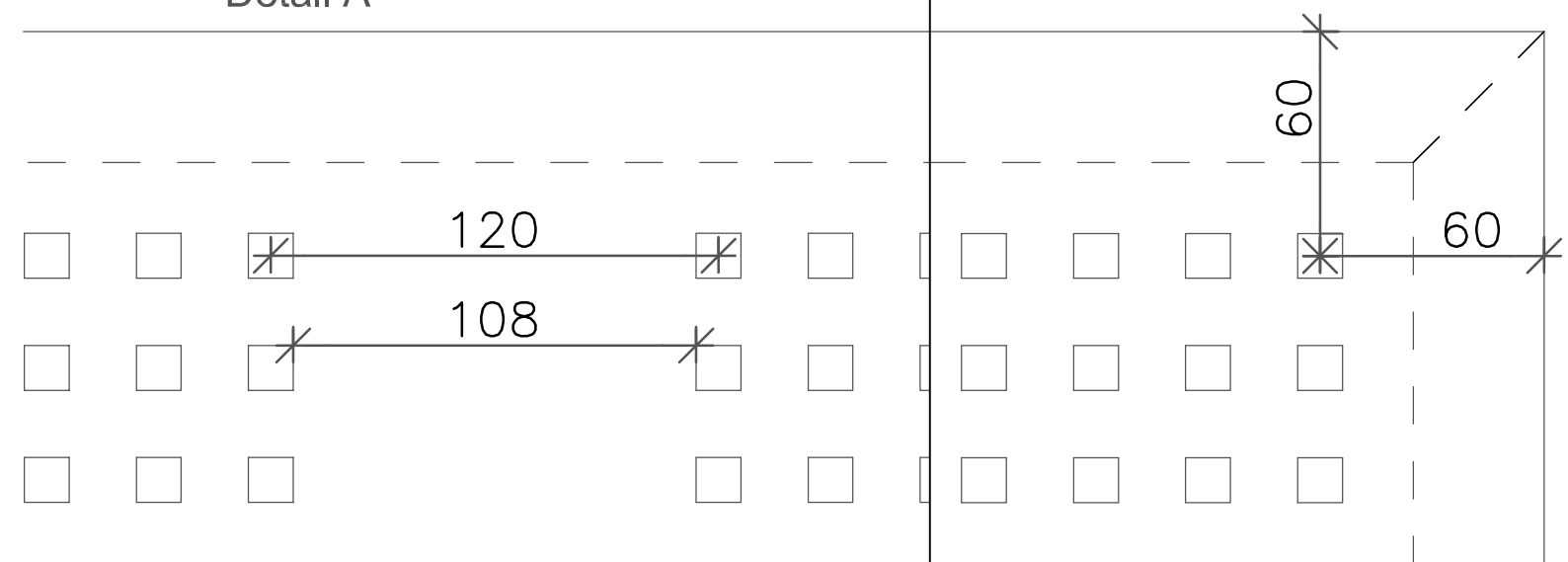

Perforation pattern:
 Perforation percentage:
 Edge type:
 Module:
 Visible measure (primary):
 External measure (secondary):
 A measure:
 Perforation picture:

Quadril Q1F (12x12mm holes cc 30mm)
 13 %
 Designpanel B (Tapered edge)
 900 x 2700 x 12,5mm
 900 x 2700mm
 900 x 2700mm
 60mm
 3 x (780 x 780mm (27 x 27 holes))

| | |
|--|------------------|
| Project: Designpanel B, Module 900x2700, Quadril Q1F | MDM no.: 254183 |
| Subject: | Scale: |
|  | Date: 2018-07-09 |
| | Rev.: |
| <small>Knauf Danoline A/S Kløvermarksvej 6, DK-9500 Hobro T: +45 9657 3000 F: +45 9657 3001 www.knaufdanoline.com - info@knaufdanoline.com</small> | Sign.: NPJ |
| | Project no.: |
| | File: |

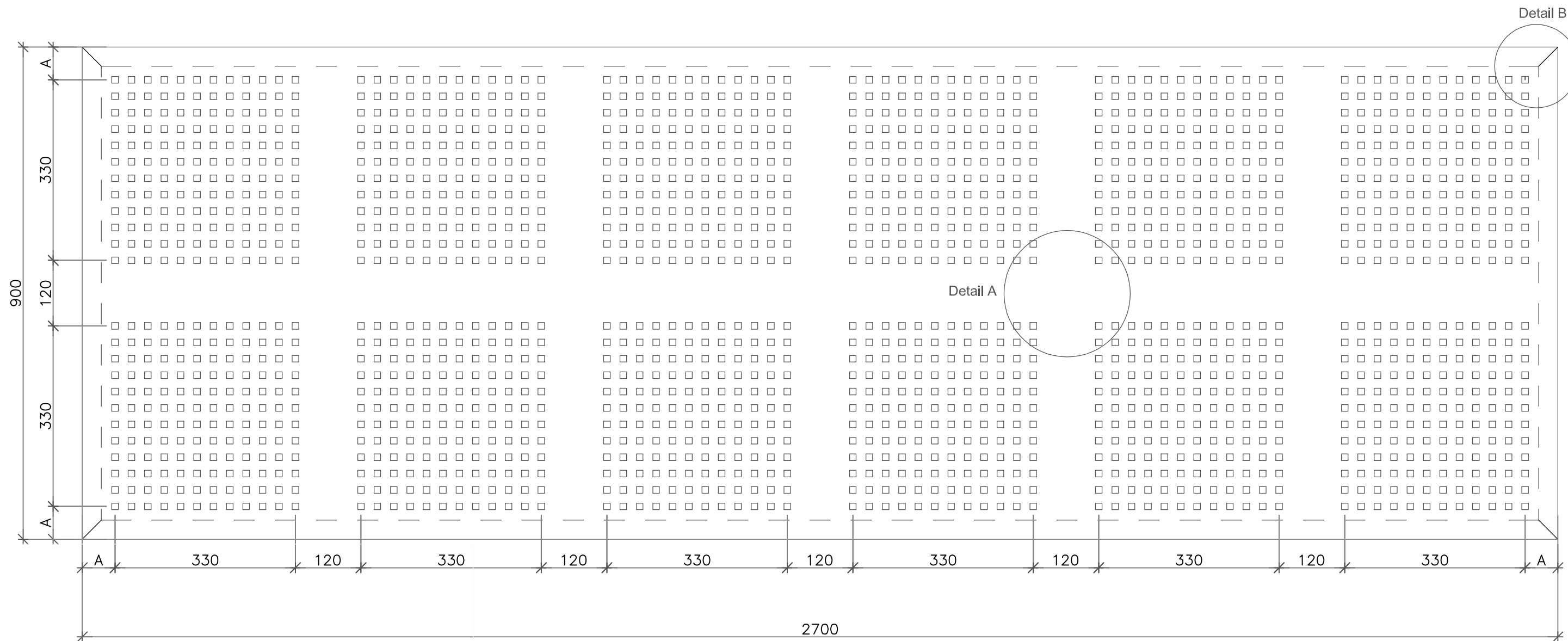

Detail A

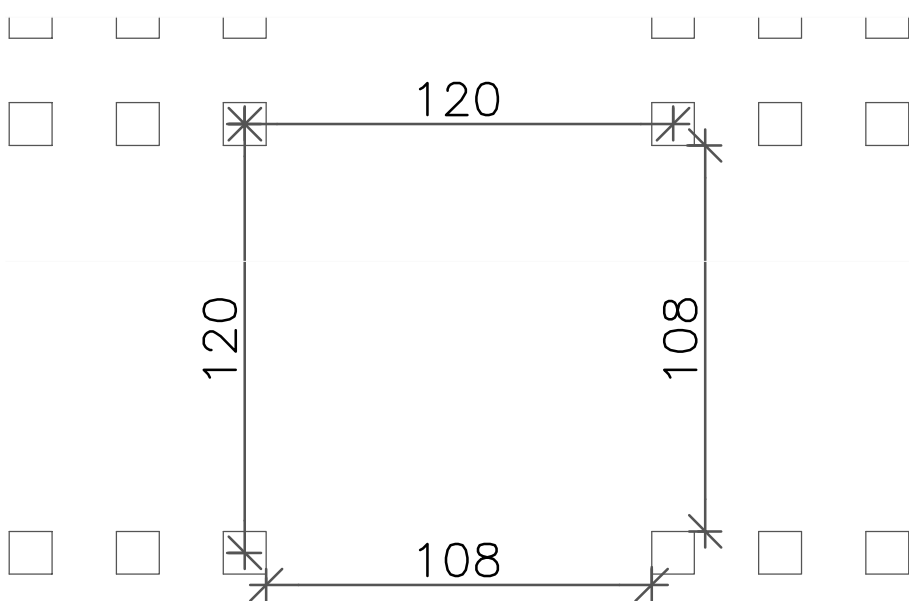

Detail B

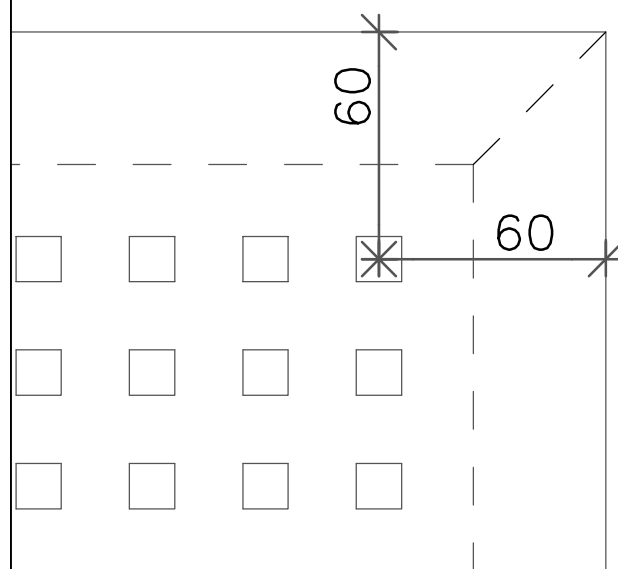

Perforation pattern: Quadril Q2F (12x12mm holes cc 30mm)
 Perforation percentage: 10,2 %
 Edge type: Designpanel B (Tapered edge)
 Module: 900 x 2700 x 12,5mm
 Visible measure (primary): 900 x 2700mm
 External measure (secondary): 900 x 2700mm
 A measure: 60mm
 Perforation picture: (2x6) x (330 x 330mm (12 x 12 holes))

| | |
|---|------------------|
| Project: Designpanel B, Module 900x2700, Quadril Q2F | MDM no.: 254184 |
| Subject: | Scale: |
| KNAUF DANOLINE | Date: 2018-07-09 |
| | Rev.: |
| Knauf Danoline A/S Kløvermarksvej 6, DK-9500 Hobro T: +45 9657 3000 F: +45 9657 3001 www.knaufdanoline.com - info@knaufdanoline.com | Sign.: NPJ |
| | Project no.: |
| | File: |

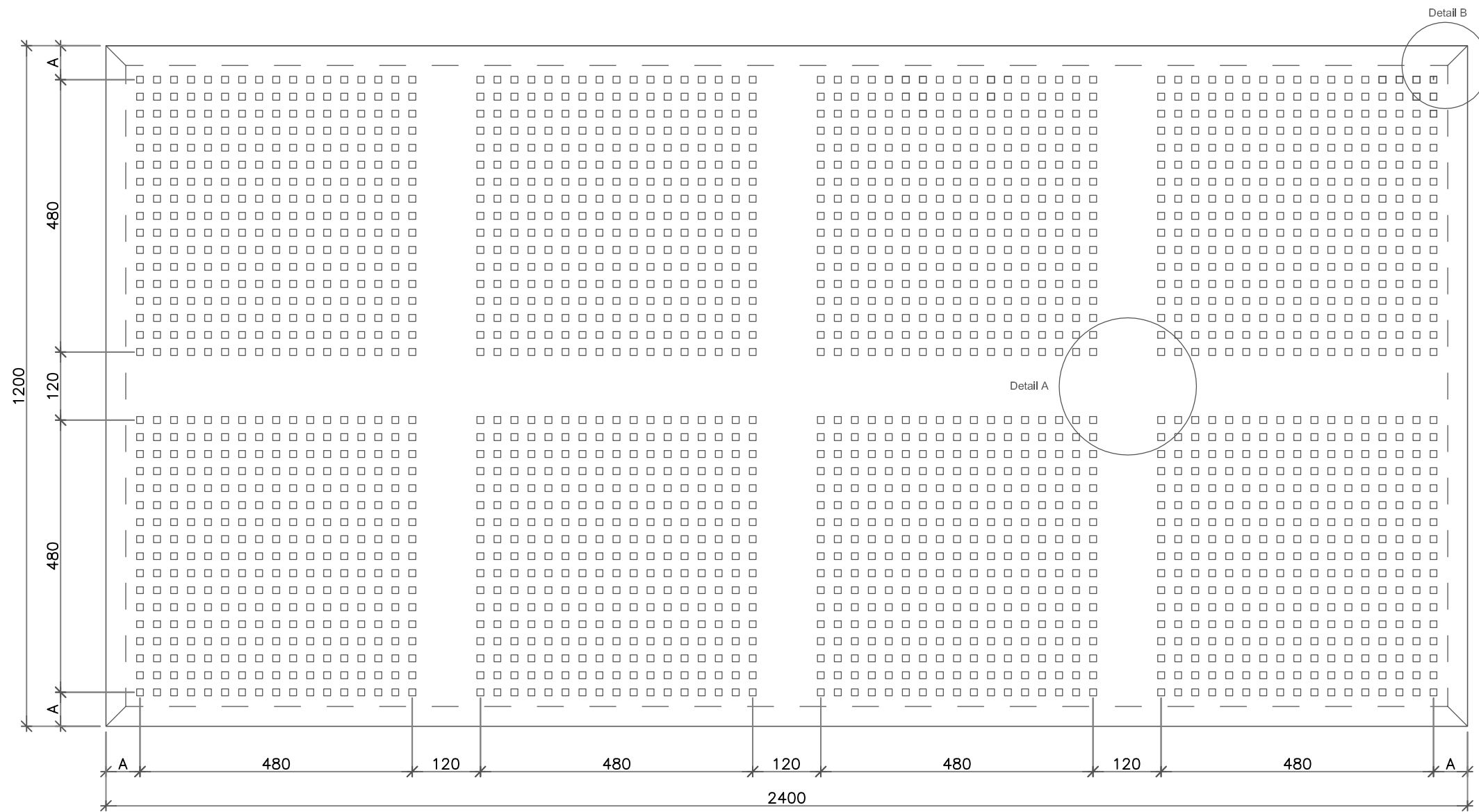

Detail A

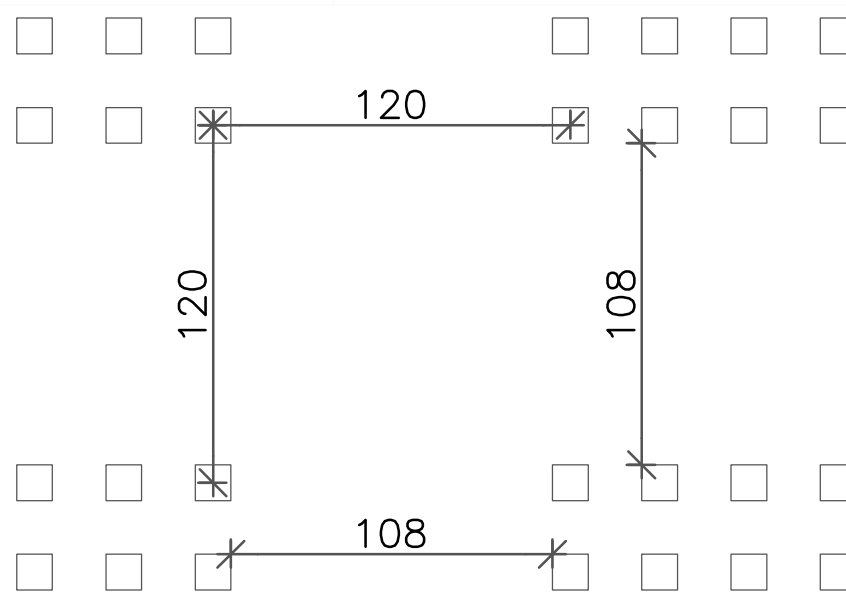

Detail B

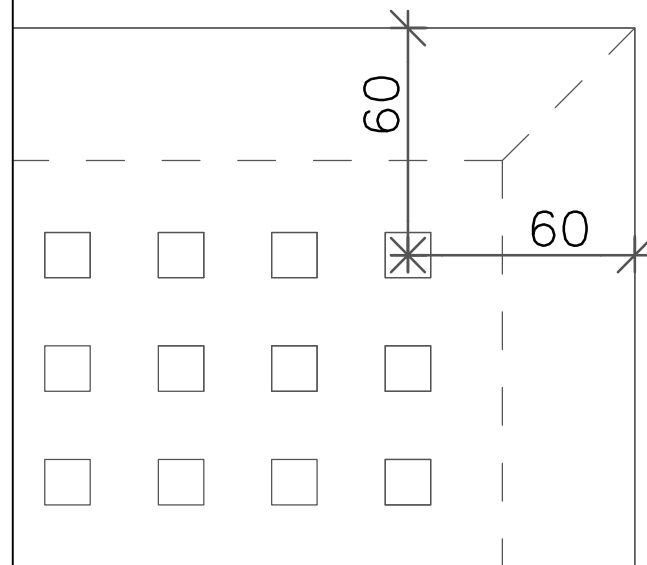

Perforation pattern:
 Perforation percentage:
 Edge type:
 Module:
 Visible measure (primary):
 External measure (secondary):
 A measure:
 Perforation picture:

Quadril Q2F (12x12mm holes cc 30mm)
 11,6 %
 Designpanel B (Tapered edge)
 1200 x 2400 x 12,5mm
 1200 x 2400mm
 1200 x 2400mm
 60mm
 (2x4) x (480 x 480mm (17 x 17 holes))

| | |
|---|------------------|
| Project: Designpanel B, Module 1200x2400, Quadril Q2F | MDM no.: 254209 |
| Subject: | Scale: |
| KNAUF DANOLINE | Date: 2018-07-10 |
| | Rev.: |
| Knauf Danoline A/S Kløvermarksvej 6, DK-9500 Hobro T: +45 9657 3000 F: +45 9657 3001 www.knaufdanoline.com - info@knaufdanoline.com | Sign.: NPJ |
| | Project no.: |
| | File: |

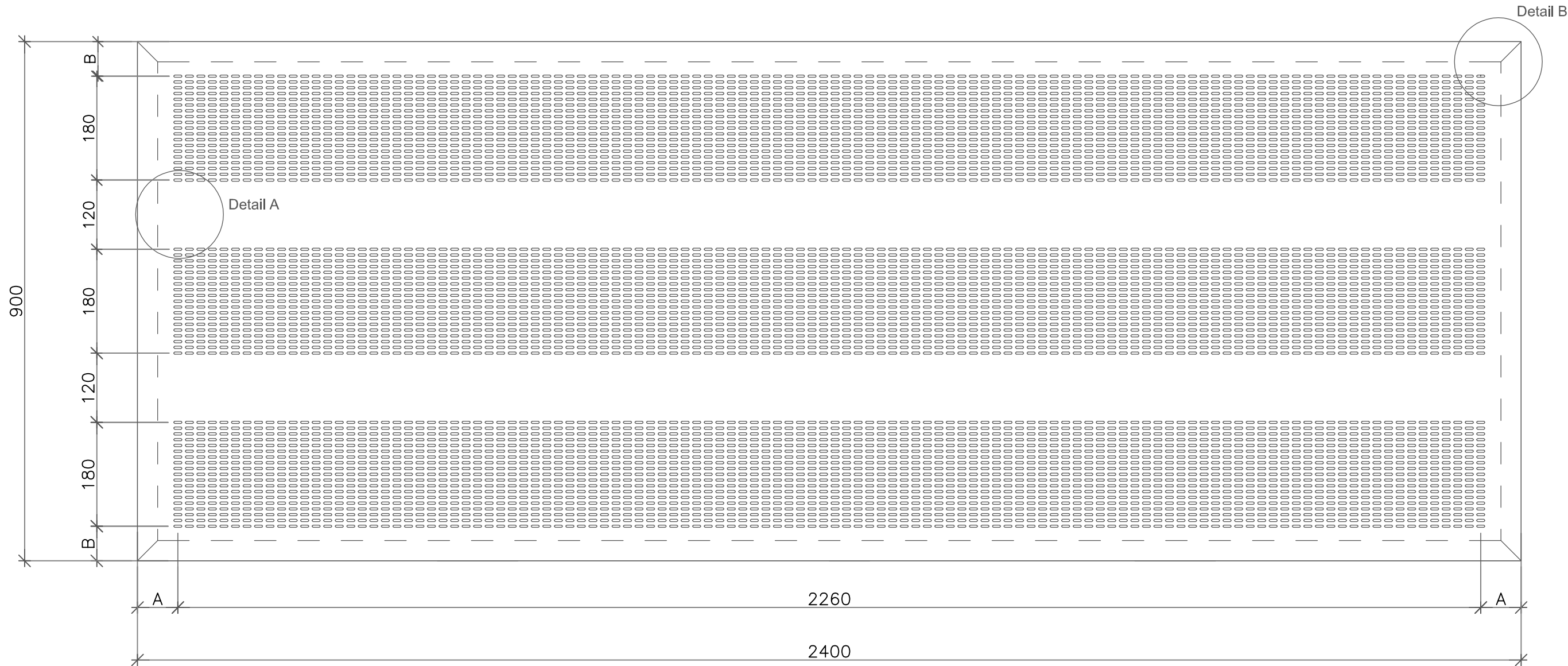

Detail A

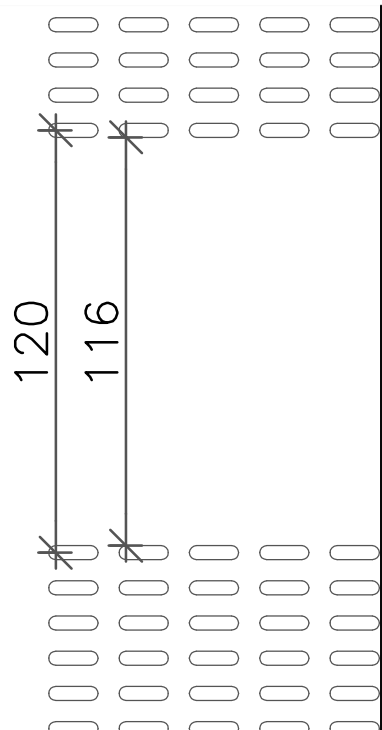

Detail B

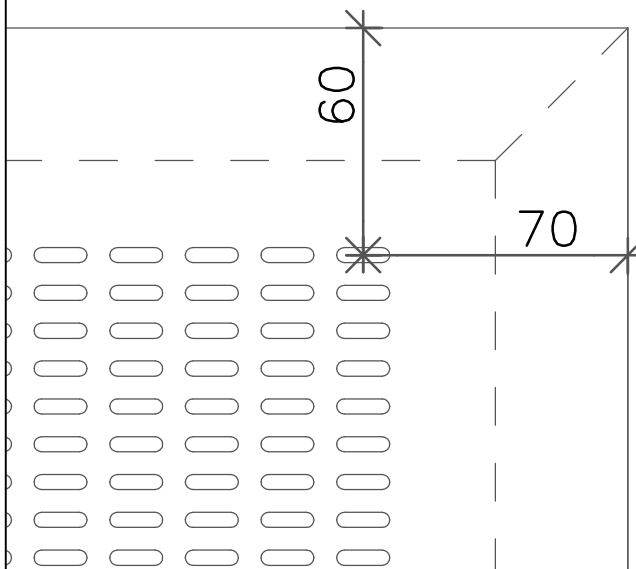

Perforation pattern: Tangent T3L1 (4x14mm holes cc 10/20mm)
 Perforation percentage: 15,8 %
 Edge type: Designpanel B (Tapered edge)
 Module: 900 x 2400 x 12,5mm
 Visible measure (primary): 900 x 2400mm
 External measure (secondary): 900 x 2400mm
 A measure: 70mm
 B measure: 60mm
 Perforation picture: 3 x (2260 x 180mm (114 x 19 holes))

| | |
|---|------------------|
| Project: Designpanel B, Module 900x2400, Tangent T3L1 | MDM no.: 254185 |
| Subject: | Scale: |
|  | Date: 2018-07-09 |
| | Rev.: |
| Knauf Danoline A/S Kløvermarksvej 6, DK-9500 Hobro T: +45 9657 3000 F: +45 9657 3001 www.knaufdanoline.com - info@knaufdanoline.com | Sign.: NPJ |
| | Project no.: |
| | File: |

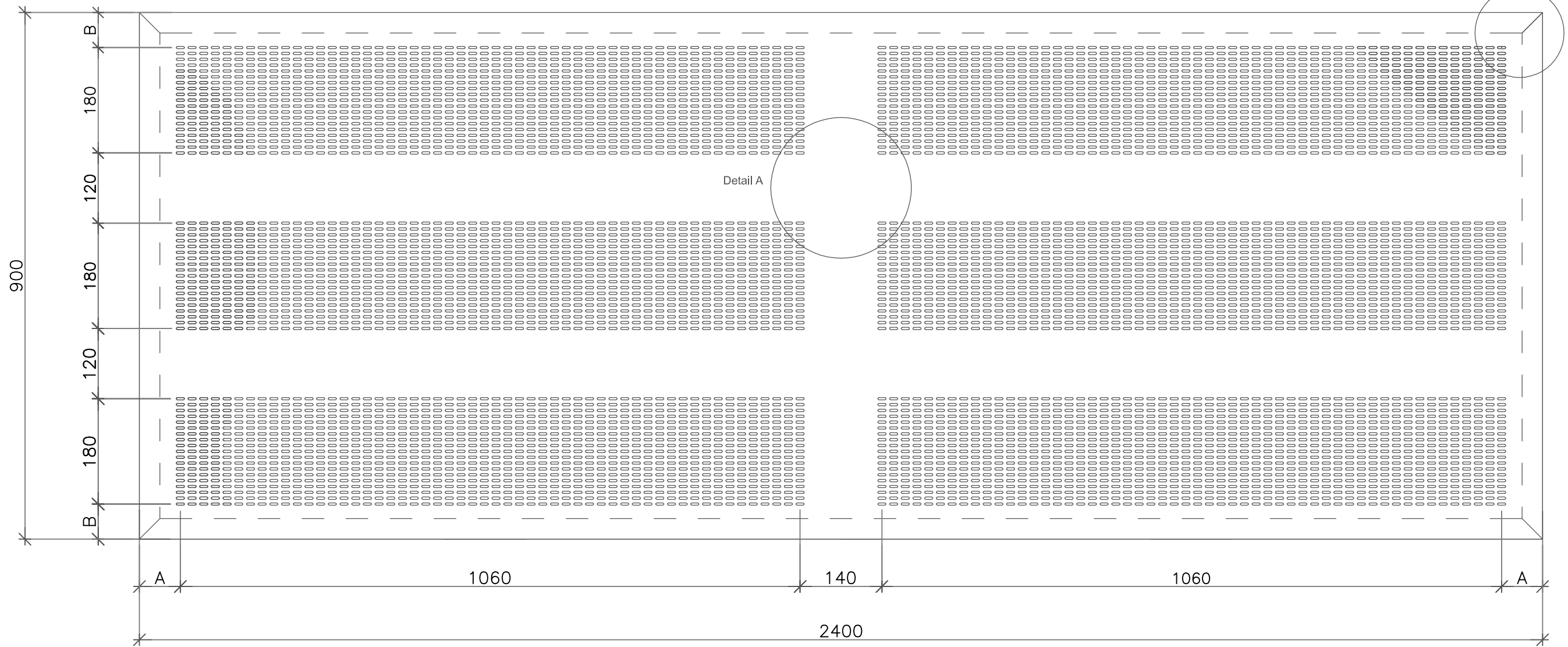

Detail A

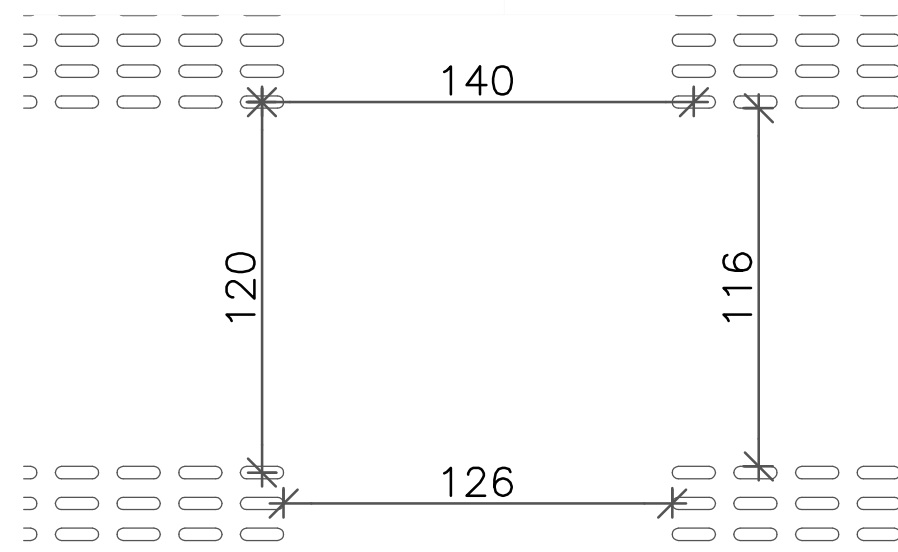

Detail B

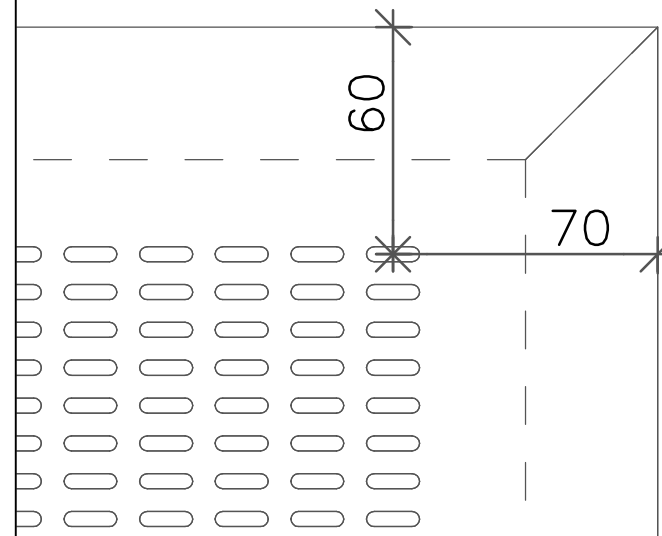

Perforation pattern: Tangent T3L2 (4x14mm holes cc 10/20mm)
 Perforation procentage: 15,0 %
 Edge type: Designpanel B (Tapered edge)
 Module: 900 x 2400 x 12,5mm
 Visible measure (primary): 900 x 2400mm
 External measure (secondary): 900 x 2400mm
 A measure: 70mm
 B measure: 60mm
 Perforation picture: (3x2) x (180 x 1060mm (19 x 54 holes))

| | |
|---|------------------|
| Project: Designpanel B, Module 900x2400, Tangent T3L2 | MDM no.: 254186 |
| Subject: | Scale: |
|  | Date: 2018-07-09 |
| | Rev.: |
| Knauf Danoline A/S Kløvermarksvej 6, DK-9500 Hobro T: +45 9657 3000 F: +45 9657 3001 www.knaufdanoline.com - info@knaufdanoline.com | Sign.: NPJ |
| | Project no.: |
| | File: |

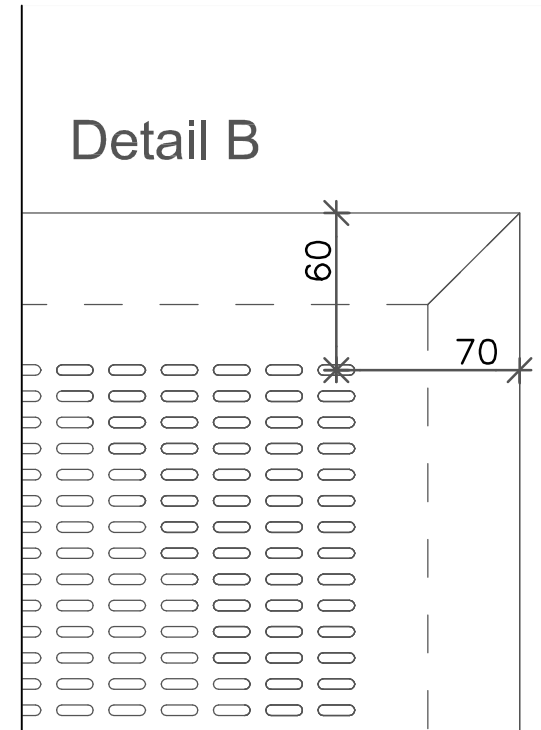
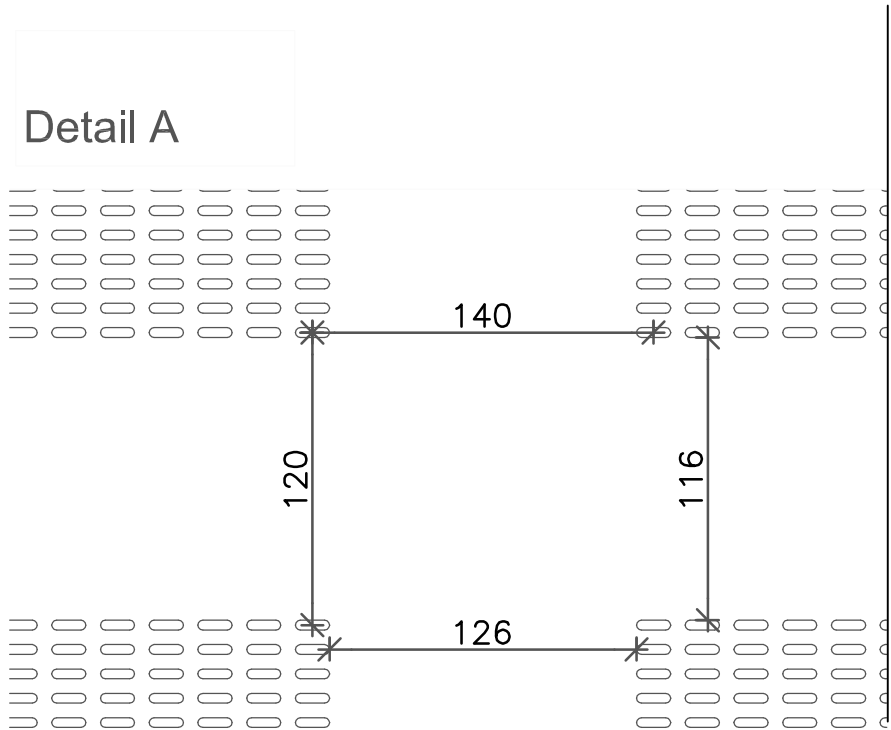
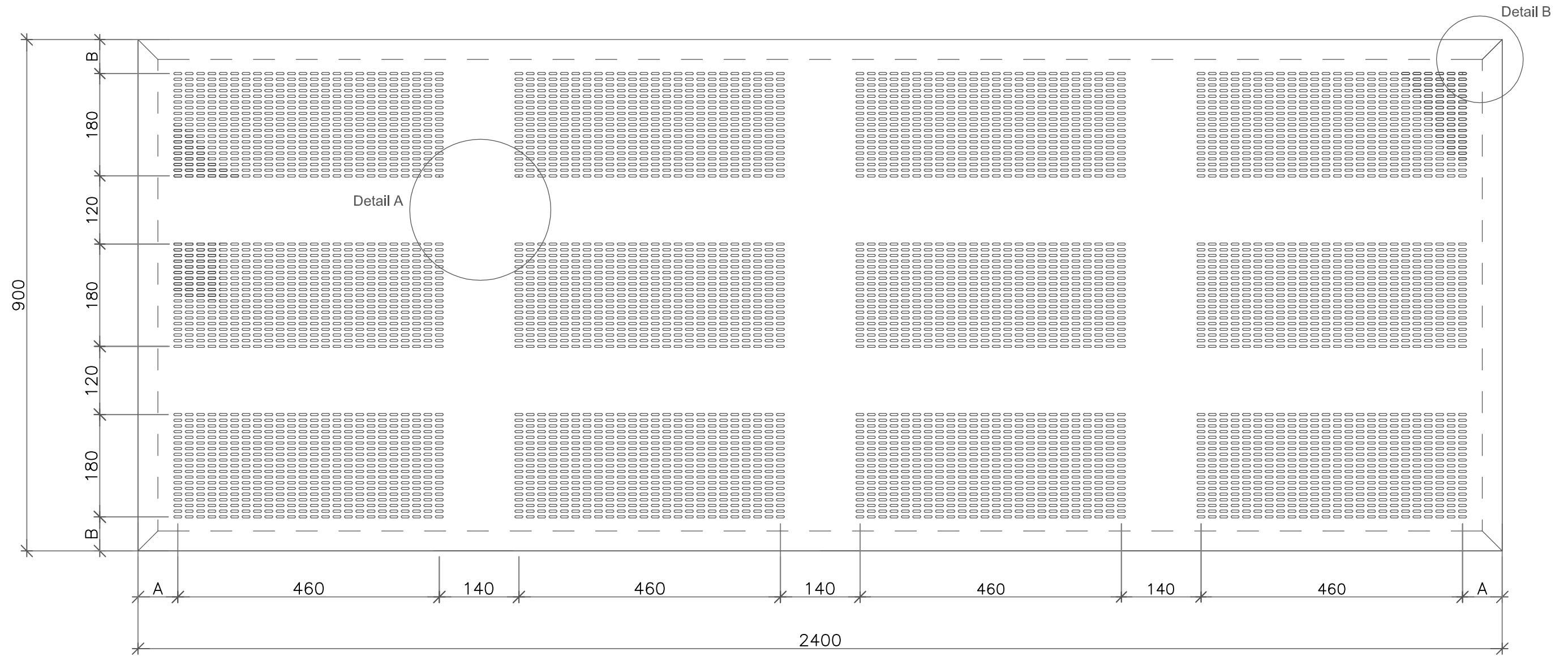

Perforation pattern: Tangent T3L4 (4x14mm holes cc 10/20mm)
 Perforation percentage: 13,3 %
 Edge type: Designpanel B (Tapered edge)
 Module: 900 x 2400 x 12,5mm
 Visible measure (primary): 900 x 2400mm
 External measure (secondary): 900 x 2400mm
 A measure: 70mm
 B measure: 60mm
 Perforation picture: (3x4) x (180 x 460mm (19 x 24 holes))

| | |
|--|------------------|
| Project: Designpanel B, Module 900x2400, T3L4 | MDM no.: 254211 |
| Subject: | Scale: |
|  | Date: 2018-07-09 |
| | Rev.: |
| <small>Knauf Danoline A/S Kløvermarksvej 6, DK-9500 Hobro T: +45 9657 3000 F: +45 9657 3001 www.knaufdanoline.com - info@knaufdanoline.com</small> | Sign.: NPJ |
| | Project no.: |
| | File: |